

## Domino 2

Domino 2 4000K 24D 6W

PRODUCT NUMBER -

1.XXXXX.D1.O1-024.940.08.HE.G1

PROJECT NAME -

### PRODUCT DATASHEET

#### PRODUCT OVERVIEW

Application	Office, Retail, Residential, Leisure, Hospitality & Healthcare
Description	Recessed multi cell downlight, ranging from 1 spot to 10 spot. Available in 24 and 40 degree, the smaller downlights are fixed while the 5 and 10 cell are available as a wall wash, a fixed and an adjustable. All come with interchangeable reflectors and are available in any specified RAL. Escapeform 1 provides emergency output.

#### PHYSICAL PROPERTIES

Dimensions (mm) L x W x H:	45 x 70 x 60
Weight (kg)	0.124
Material	Diffuser: PC, Body: Aluminium
Colour	Matt, White, Gold and Black and any other RAL on request
Fixing type	Recessed spring clips
IP rating	IP20

#### PHOTOMETRIC PROPERTIES

Optic	Clear
Output mode	High Efficiency
Beam angle (°)	24°
Colour temperature (K)	4000
Colour Rendering Index (CRI)	>90
Direct lumen output (lm)	363
Wattage (W)	6
Efficacy (lm/W)	61

#### ELECTRICAL PROPERTIES

Supply voltage (V)	220-240
Supply frequency (Hz)	0 / 50 / 60
Current (mA)	700
Control	Non Dim, Phase Dim, 1-10V, DALI
Safety class	II
LED Life (L70B50) (hrs)	83000

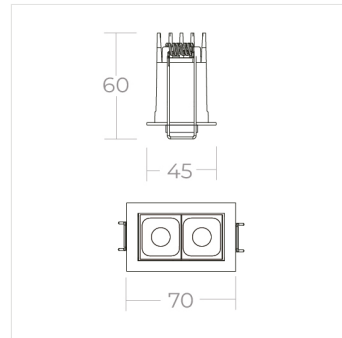

#### Terms and Conditions

© 2024 Formation Lighting. All rights reserved. The information in this datasheet is for informational purposes only and may change without notice. Technical data are rated for 25°C ambient temperature with a tolerance of +/- 10% for luminous flux and +/- 150 K for colour temperature. The UGR is calculated from a room with 4H/8H dimensions and reflectance of 20% floor, 50% walls, and 70% ceiling using the SHR 1:1. Use of this datasheet is subject to our terms and conditions, available at [formationlighting.com](http://formationlighting.com)