

Domino 2x2

Domino 2x2 3000K 24D 11W

PRODUCT NUMBER -

1.XXXXX.D1.O1-024.930.08.HE.G1

PROJECT NAME -

PRODUCT DATASHEET

PRODUCT OVERVIEW

Application	Office, Retail, Residential, Leisure, Hospitality & Healthcare
Description	Recessed multi cell downlight, ranging from 1 spot to 10 spot. Available in 24 and 40 degree, the smaller downlights are fixed while the 5 and 10 cell are available as a wall wash, a fixed and an adjustable. All come with interchangeable reflectors and are available in any specified RAL. Escapeform 1 provides emergency output.

PHYSICAL PROPERTIES

Dimensions (mm) L x W x H:	75 x 75 x 60
Weight (kg)	0.2133
Material	Diffuser: PC, Body: Aluminium
Colour	Matt, White, Gold and Black and any other RAL on request
Fixing type	Recessed spring clips
IP rating	IP20

PHOTOMETRIC PROPERTIES

Optic	Clear
Output mode	High Efficiency
Beam angle (°)	24°
Colour temperature (K)	3000
Colour Rendering Index (CRI)	>90
Direct lumen output (lm)	749
Wattage (W)	11
Efficacy (lm/W)	68

ELECTRICAL PROPERTIES

Supply voltage (V)	220-240
Supply frequency (Hz)	0 / 50 / 60
Current (mA)	700
Control	Non Dim, Phase Dim, 1-10V, DALI
Safety class	II
LED Life (L70B50) (hrs)	83000

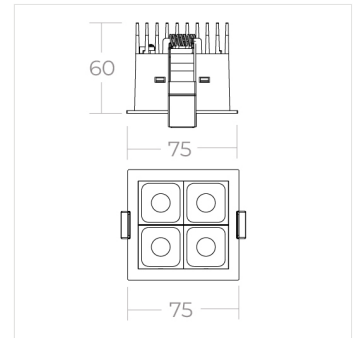

Terms and Conditions

© 2024 Formation Lighting. All rights reserved. The information in this datasheet is for informational purposes only and may change without notice. Technical data are rated for 25°C ambient temperature with a tolerance of +/- 10% for luminous flux and +/- 150 K for colour temperature. The UGR is calculated from a room with 4H/8H dimensions and reflectance of 20% floor, 50% walls, and 70% ceiling using the SHR 1:1. Use of this datasheet is subject to our terms and conditions, available at formationlighting.com